

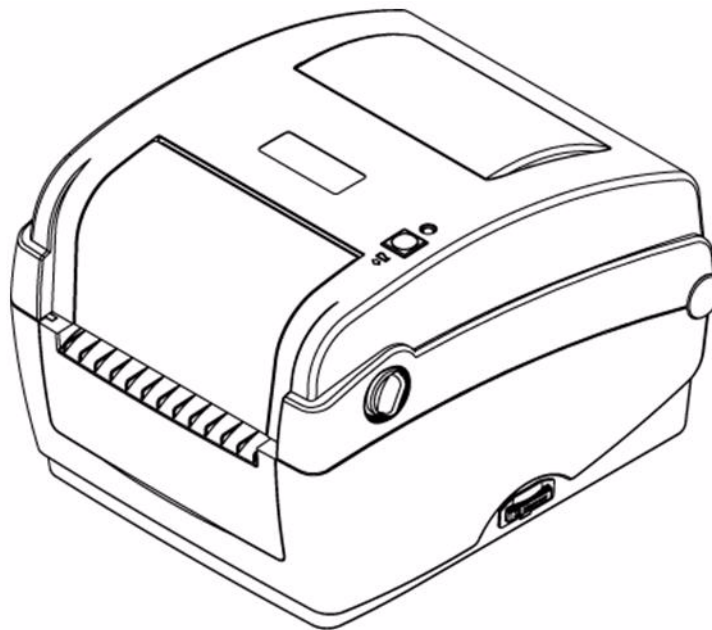

**BBP11-34L**

# **Thermal Transfer Printer**

## **User Guide**



Ed 08/09

# Contents

## Introduction

<i>Product Introduction</i> .....	1
<i>Compliance</i> .....	1

## Operations Overview

<i>Unpacking and Inspection</i> .....	2
<i>Printer Overview</i> .....	3

## Setup

<i>Setting Up the Printer</i> .....	6
<i>Open / Close the Top Cover</i> .....	7
<i>Loading the Ribbon</i> .....	8
<i>Loading the Media</i> .....	11
<i>Diagnostic Tool</i> .....	18
<i>Install SD Memory Card</i> .....	20

## LED and Button Functions

<i>LED Indicator</i> .....	21
<i>Regular Button Function</i> .....	21
<i>Power on Utilities</i> .....	22

## Troubleshooting..... 27

## Maintenance ..... 29

## Copyright

This manual is copyrighted with all rights reserved. No portion of this manual may be copied or reproduced by any means without the prior consent of **Brady Worldwide, Inc.**

While every precaution has been taken in preparation of this document, **Brady** assumes no liability to any party for any loss or damage caused by errors or omissions or by statements resulting from negligence, accident, or any other cause. **Brady** further assumes no liability arising out of the application or use of any product or system described, herein; nor any liability for incidental or consequential damages arising from the use of this document. **Brady** disclaims all warranties of merchantability or fitness for a particular purpose.

**Brady** reserves the right to make changes without further notice to any product or system herein to improve reliability, function, or design.

Reproduction of this material, in part or whole, is strictly prohibited without the written permission of **Brady Worldwide, Inc.** For more information, contact: **Brady Worldwide, Inc.** Signmark® Division, 2221 W. Camden Road, Milwaukee, WI 53209.

## Disclaimer

Every effort has been made to make this guide as accurate and complete as possible. **Brady Worldwide, Inc.** is not responsible for inaccuracies and omissions occurring during the use of this guide.

This manual is proprietary to **Brady Worldwide, Inc.** and may be revised from time to time without notice. **Brady Worldwide, Inc.** disclaims any understanding to provide you with revisions, if any.

All brand or product names referenced in this manual are trademarks or registered trademarks of their respective companies or organizations.

© 2009 Brady Worldwide, Inc. All rights reserved.  
[www.bradycorp.com](http://www.bradycorp.com)

Edition 08/09



Identification Solutions Division  
PO Box 2131  
Milwaukee, WI 53201 U.S.A.  
Phone: 1-800-537-8791 Fax: 1-800-292-2289

## Revision History

Date	Content
2008/8/6	Revise the 3.4.3 section(Loading media in peel-off mode)
2009/08	Revise to include new Brady Standard.

## Product Introduction

Thank you for purchasing the **BRADY BBP11-34L** series bar code printer. Although the printer is small, it delivers reliable, superior performance.

This printer provides both thermal transfer and direct thermal printing at user-selectable speeds of 2.0 or 3.0 ips. It accepts roll feed, die-cut, and fan-fold labels for both thermal transfer and direct thermal printing. All common bar codes formats are available. Fonts and bar codes can be printed in 4 directions, 8 different alphanumeric bitmap fonts and built-in true type font capability. You will enjoy high throughput for printing labels with this printer.

## Compliance

CE Class B:

EN55022: 1998+A1: 2000+A2: 2003

EN55024: 1998+A1: 2001+A2: 2003 IEC 61000-4 Series

EN61000-3-2: 2006 & EN61000-3-3: 1995+A1: 2001

FCC Part 15, Class B

UL, CUL

C-Tick:

CFR 47, Part 15/CISPR 22 3<sup>rd</sup> Edition: 1997, Class B

ANSI C63.4: 2003

Canadian ICES-003

TÜV-GS: EN60950: 2000

---

**Note:** Continuous printing will cause printer motor overheat. Printer will stop printing automatically about 10~15 minutes until motor is cooled down. Do not turn off power when printer pauses or the data transferred to printer buffer will be lost.

---

---

**Note:** The maximum printing ratio per dot line is 15% for this printer. To print the full web black line, the maximum black line height is limited to 40 dots, which is 3.3 mm for 300 dpi resolution printer.

---

## Unpacking and Inspection

This printer has been specially packaged to withstand damage during shipping. Please carefully inspect the packaging and printer upon receiving the bar code printer. Retain the packaging materials in case you need to reship the printer.

### *Unpacking the Printer*

The following items are included in the carton:

- (1) Printer unit
- (1) Product CD, including drivers
- (1) Quick installation guide
- (1) Power cord
- (1) Auto switching power supply
- (1) USB interface cable

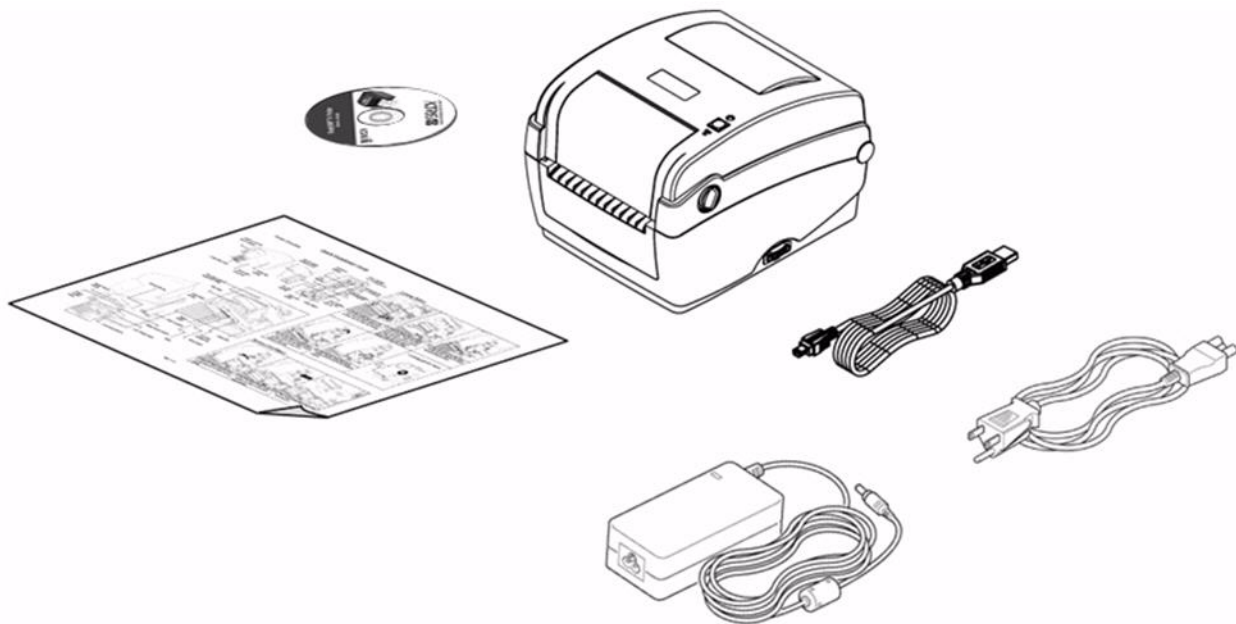

If any parts are missing, please contact customer Service.

# Printer Overview

## Front View

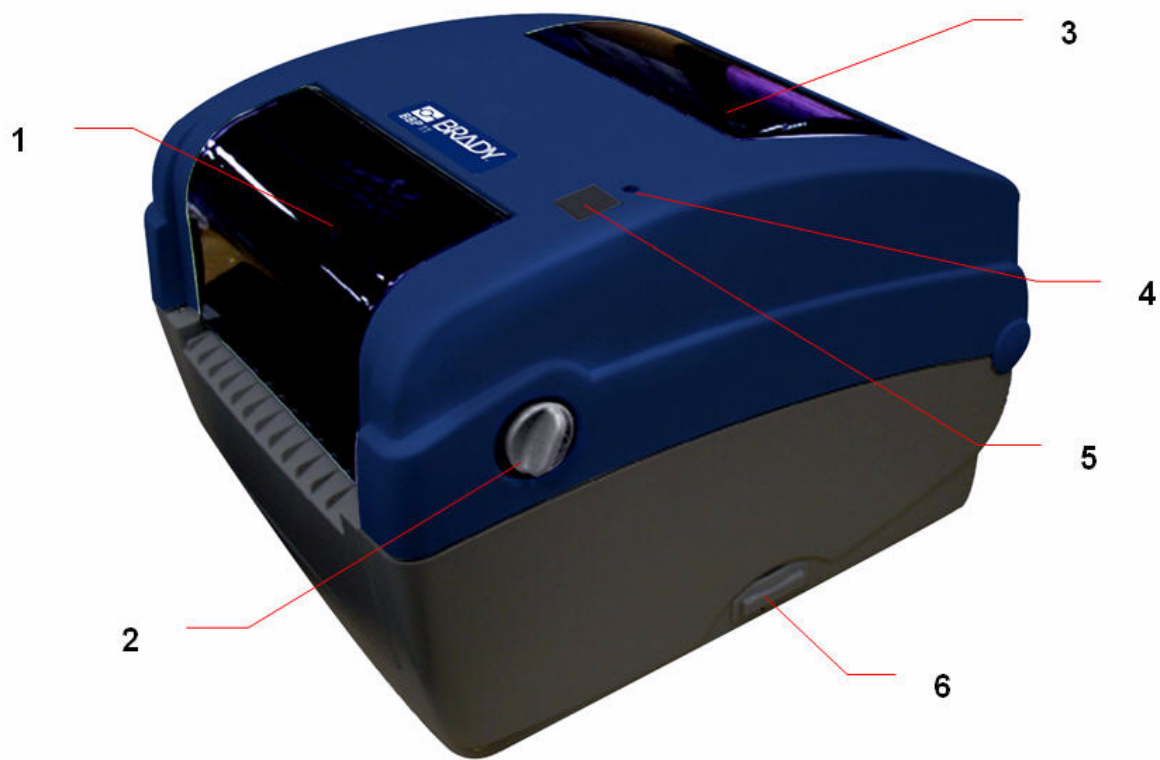

- 1 Ribbon access cover
- 2 Top cover open lever
- 3 Media view window
- 4 LED indicator
- 5 Feed button
- 6 SD card socket

<b>* Recommended SD card specification.</b>	
SD V 1.0, V 1.1	SD V 2.0 (SDHC)
✓ 128MB ✓ 256MB ✓ 512MB ✓ 1GB	✓ 4GB class 6
- Supported DOS FAT file system. - Folders stored on the SD card should be in the 8.3 filename format. - Approved SD card manufacturer: SanDisk, Transcend.	

## *Interior View*

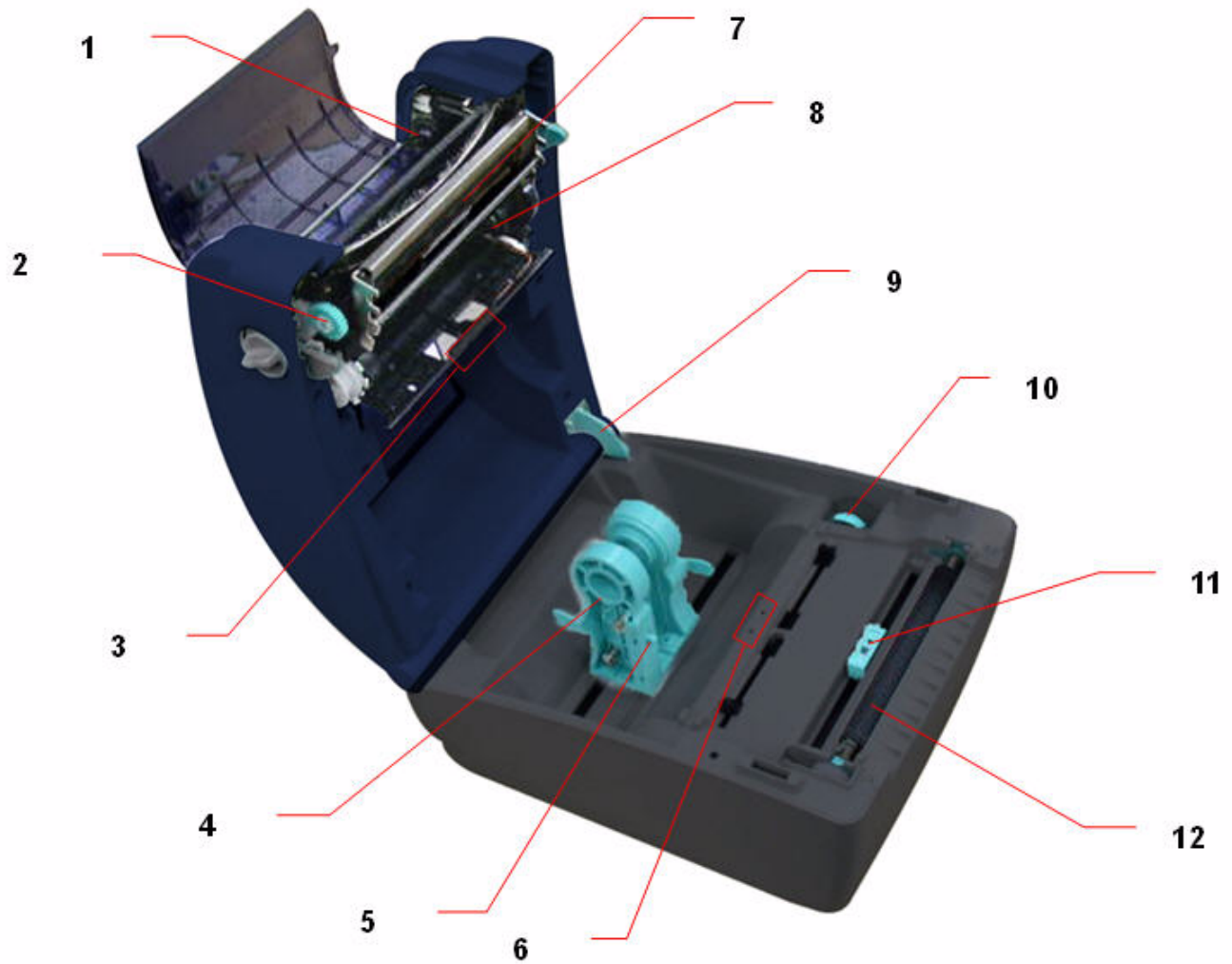

- 1** Ribbon rewind hub
- 2** Ribbon rewind gear
- 3** Gap sensor (receiver)
- 4** Media holder
- 5** Media holder lock switch
- 6** Gap sensor (transmitter)
- 7** Printhead
- 8** Ribbon supply hub
- 9** Top cover support
- 10** Media guide adjustment knob
- 11** Black mark sensor
- 12** Platen roller



## Rear View

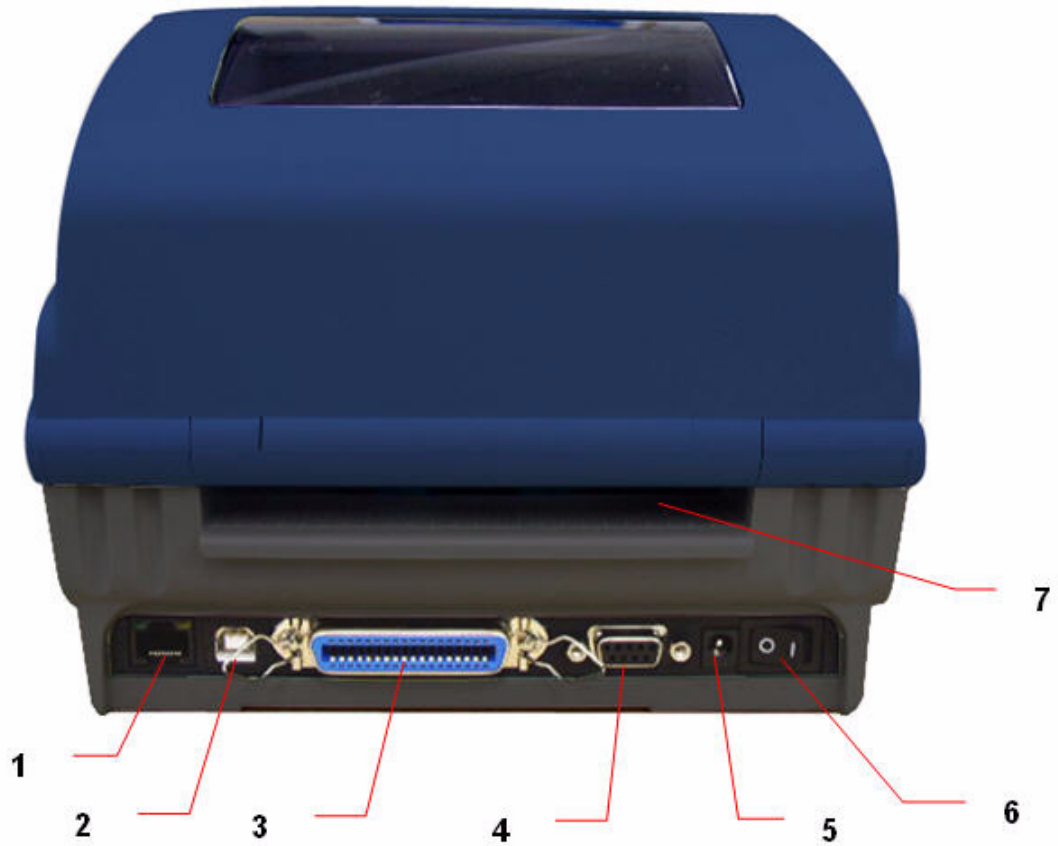

- 1 Ethernet interface
- 2 USB interface
- 3 Parallel/LPT interface
- 4 Serial/COM interface
- 5 Power jack socket
- 6 Power switch
- 7 Fan-fold paper entrance chute

## Setting Up the Printer

1. Place the printer on a flat, secure surface.
2. Make sure the power switch is off.
3. Connect the printer to the computer with the provided USB cable.
4. Plug the power cord into the AC power cord socket at the rear of the printer, and then plug the power cord into a properly grounded power outlet.

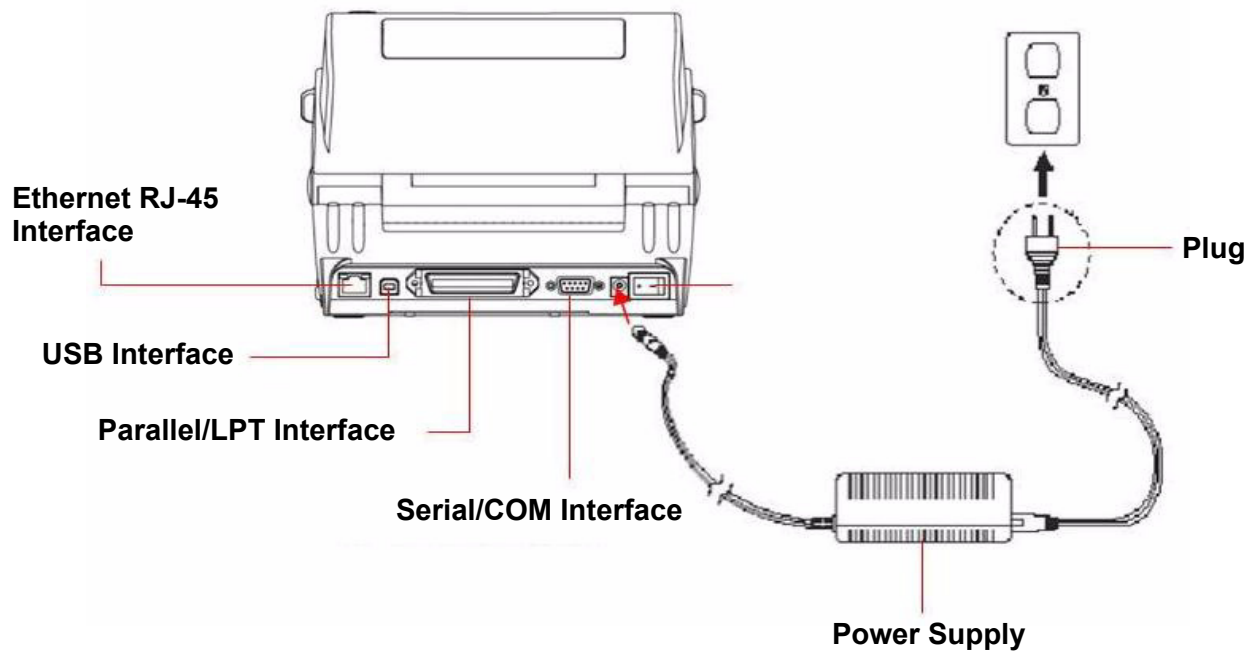

## Open / Close the Top Cover

1. Open the printer top cover by pulling the grey tabs located on each side toward the front of the printer, then lift the top cover to the maximum open angle.



2. A top cover support at the rear of the printer will engage with lower inner cover to hold the printer top cover open.

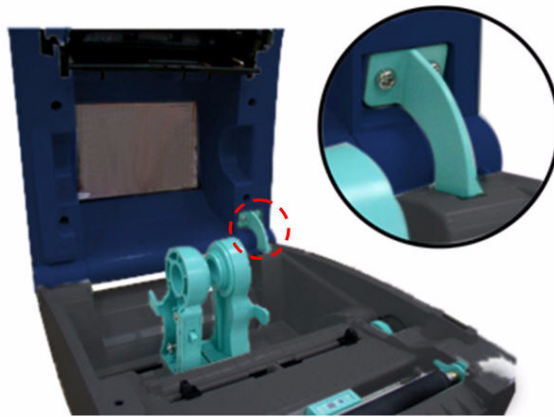

3. Hold the top cover and press the top cover support to disengage the top cover support with lower inner cover. Gently close the top cover.

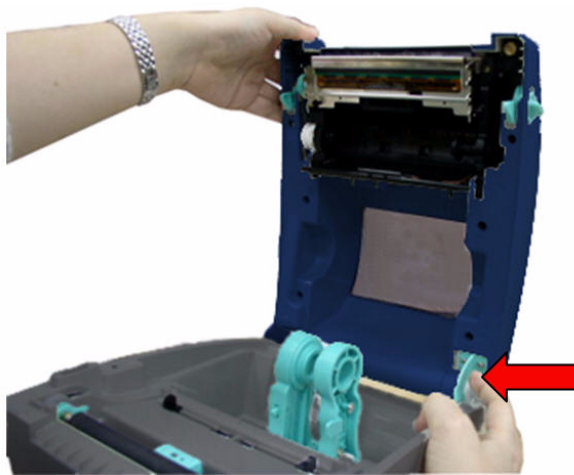

## Loading the Ribbon

1. Open the top cover on the printer by pulling the green open levers located on each side of the printer and lifting the top cover to the maximum open angle.
2. Open the ribbon access cover.

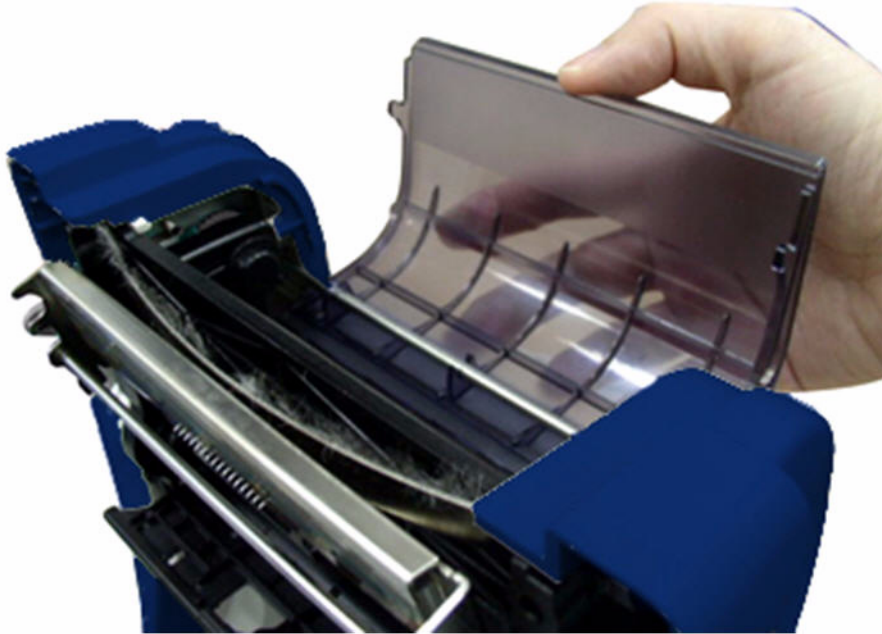

---

**Note:** In normal print mode, the ribbon access cover can be opened while opening the top cover. The ribbon access cover can be closed while the top cover is open or closed.

---

3. Insert the right side of the ribbon right onto the supply hub. Align the notches on the left side and mount onto the spokes.

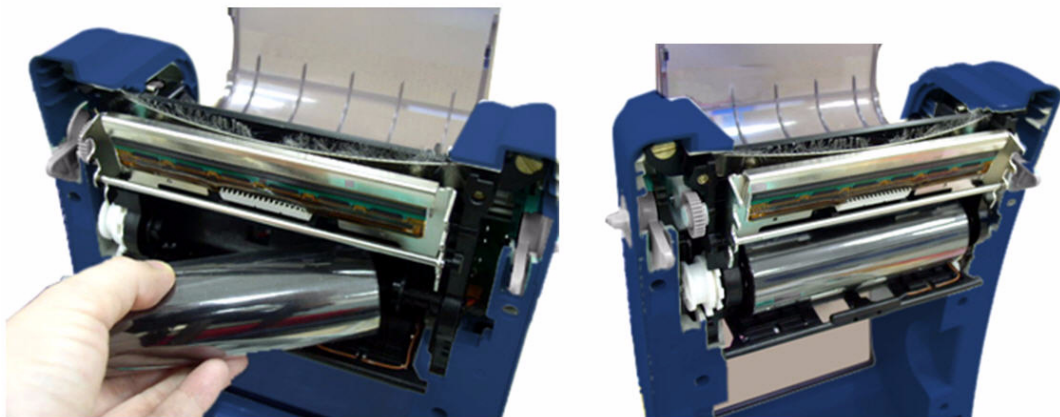

4. Insert the right side of the paper core onto the rewind hub. Align the notches on the left side and mount onto the spokes.

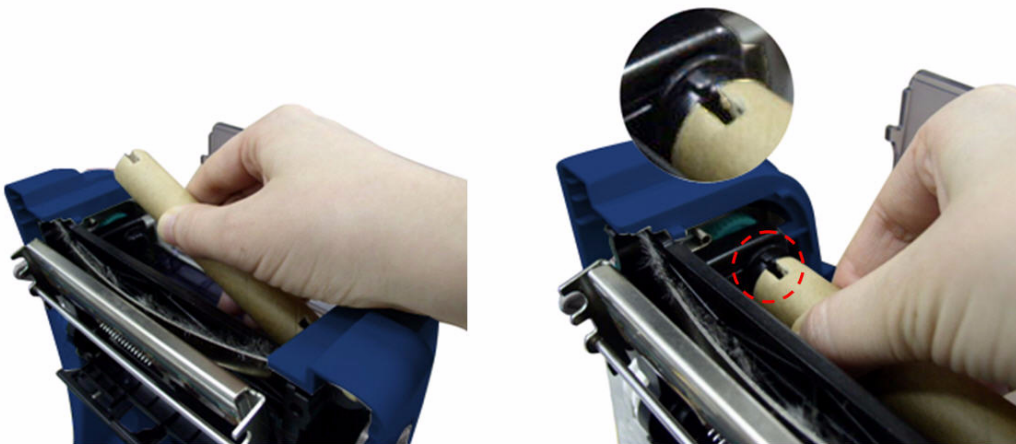

5. Attach the ribbon leader onto the ribbon rewind paper core.

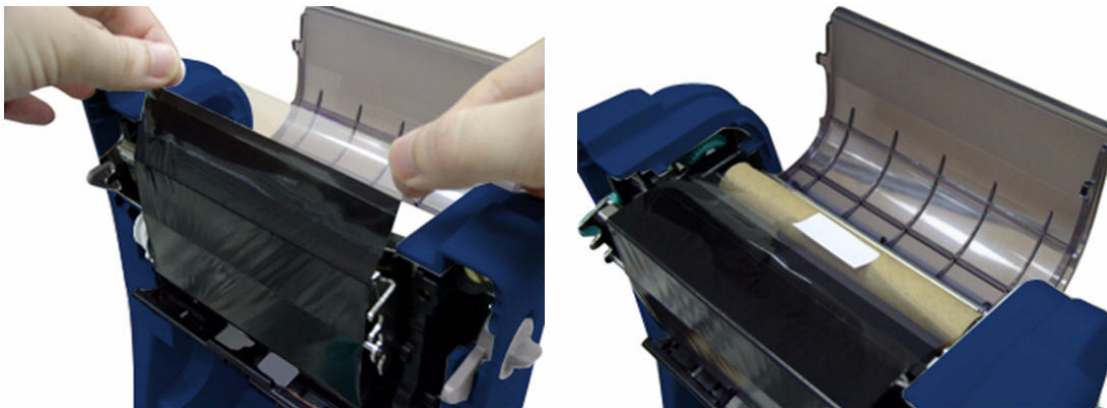

6. Turn the ribbon rewind gear until the plastic ribbon leader is thoroughly wound and the black section of the ribbon covers the print head. Close the ribbon access cover and the top cover.

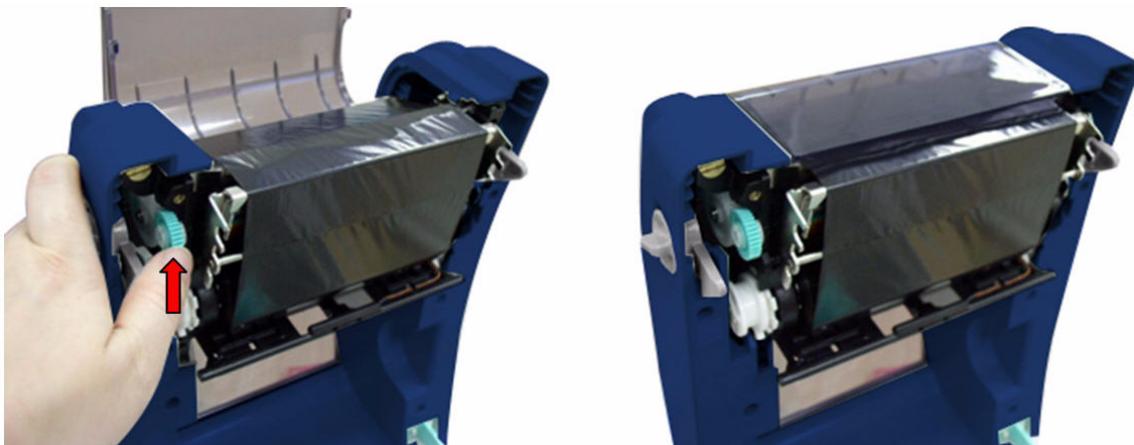

## *Ribbon Loading Path*

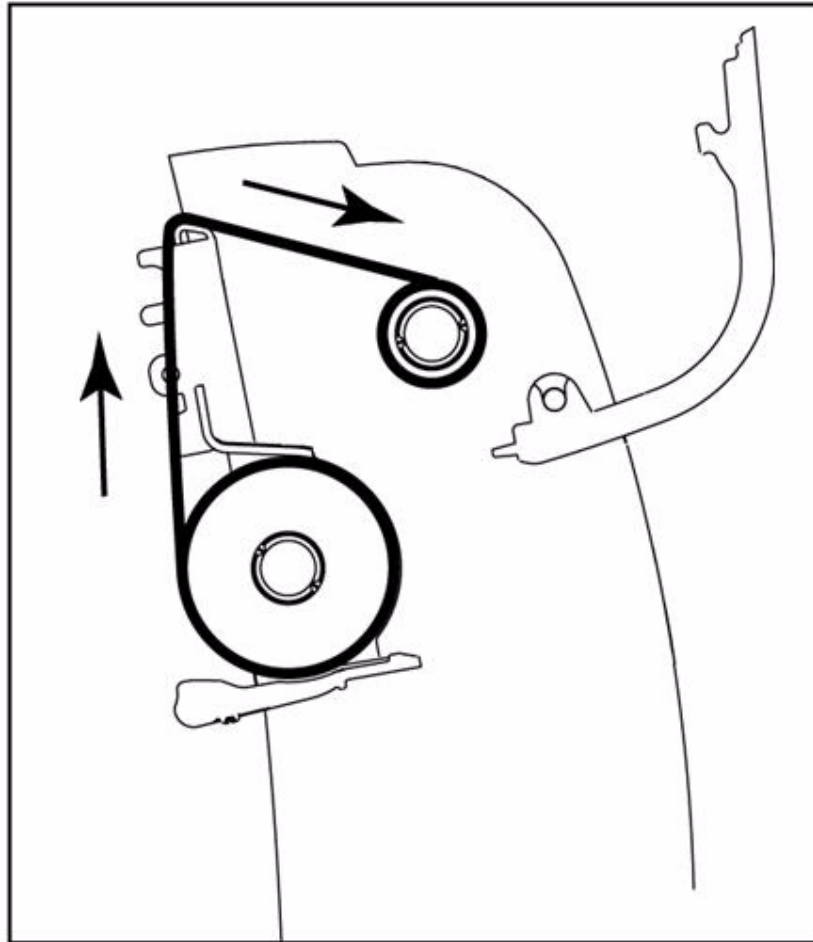



# Loading the Media

## Loading Media

1. Open the printer top cover by pulling the grey tabs, located on each side, toward the front of the printer, then lift the top cover to the maximum open angle.
2. Separate and hold open the media holders.

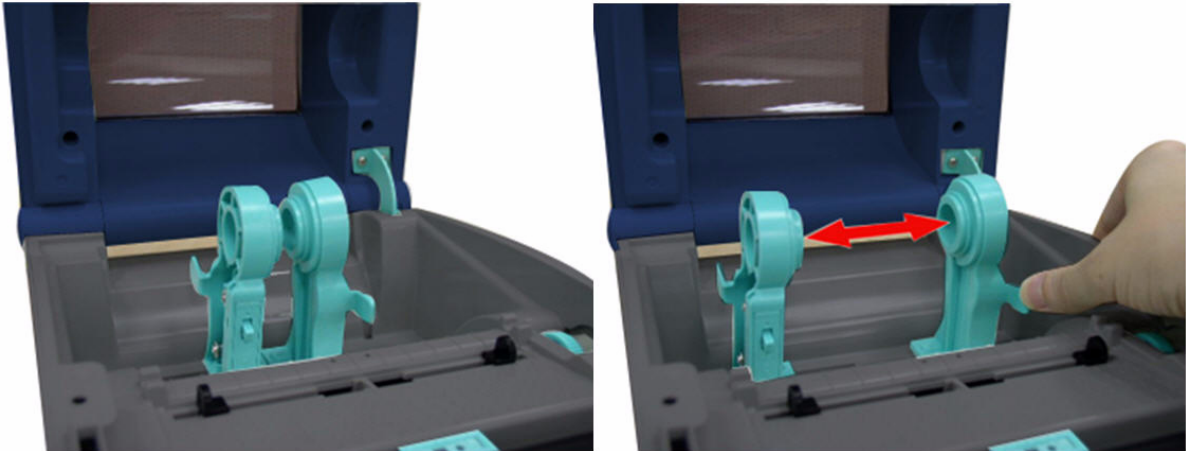

3. Place the roll between the holders and close them onto the core.

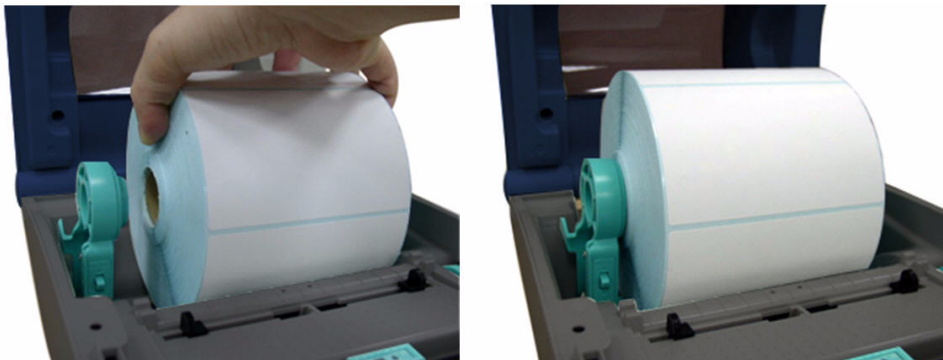

4. Set the media holder lock switch to **Lock** (down) to hold the label roll firmly.

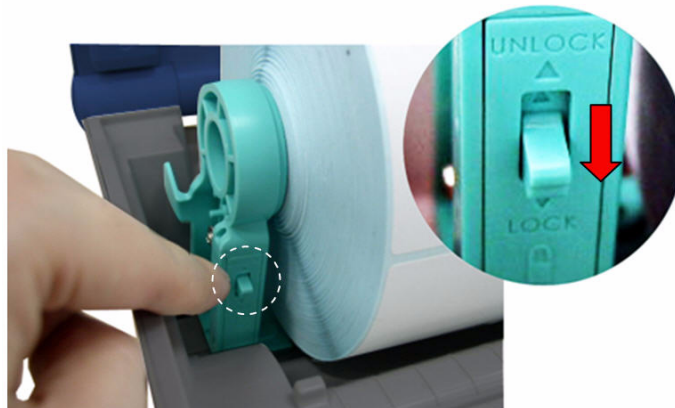

5. **Optional:** If using either an external media holder or folded labels, feed the media through the rear external label entrance chute.
6. Place the paper, print side face up, through the media sensor .
7. Place the label leading edge onto the platen roller.
8. Move the media guides to fit the label width by turning the guide adjuster knob.
9. Disengage the top cover support and close the top cover gently.

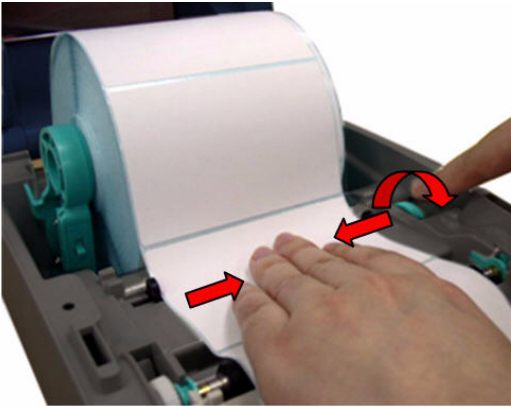

10. Use the **Diagnostic Tool** to set the media sensor type and calibrate the selected sensor (see the diagnostic utility quick start guide for more information):
  - a. Start **Diagnostic tool**.
  - b. Select **Printer Configuration** tab.
  - c. Click **Calibrate Sensor** button.

---

**Note:** Please calibrate the gap/black mark sensor when changing media.

---

### ***Loading Path for Roll Labels***

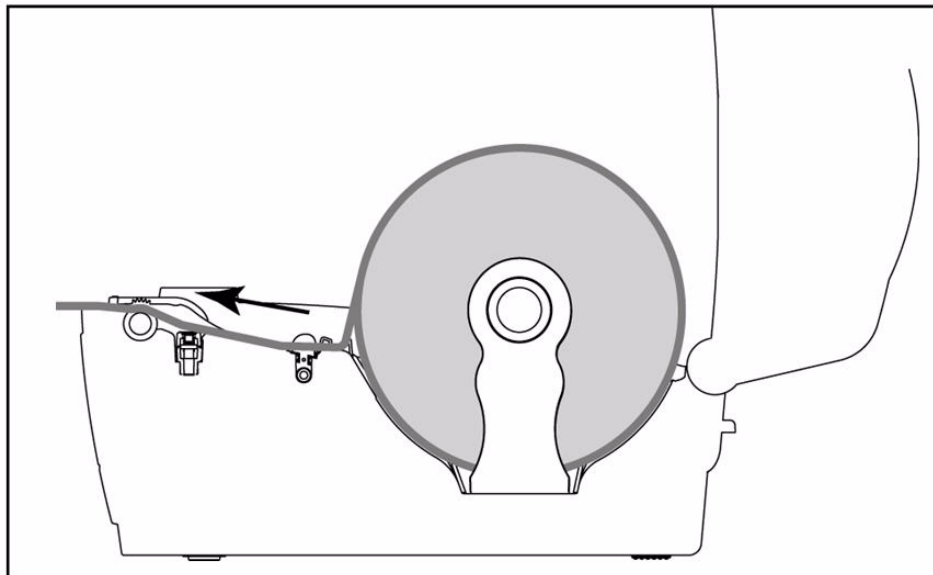



## External Label Roll Mount Installation (Option)

1. Attach an external paper roll mount on the bottom of the printer.

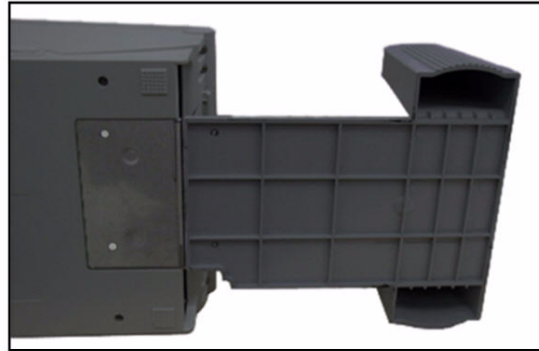

2. Insert a 1" label spindle into a paper roll and install it on the external paper roll mount.

**Note:** If your paper core is 1 inch, remove the 1.5" core adapter from the fixed tab. If label width is 4 inch wide, two fixed tabs are not required.

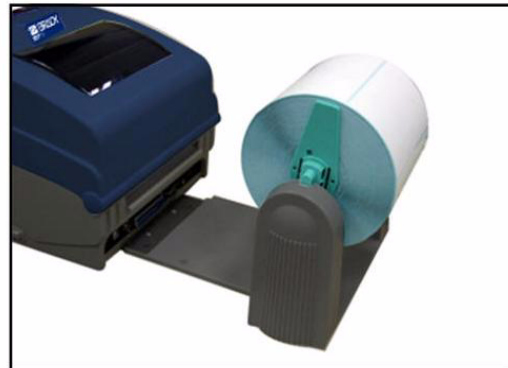
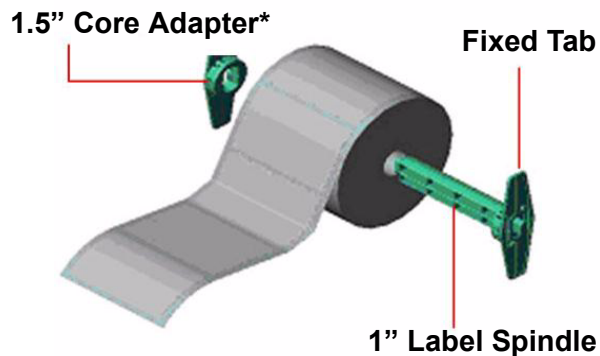

3. Open the top cover and separate the media holders to fit the media width.
4. Press down the media holder lock switch to fix the media holder.
5. Feed the media through the rear external label entrance chute:
  - a. Place the paper, print side face up, through the media sensor .
  - b. Place the label leading edge onto the platen roller.

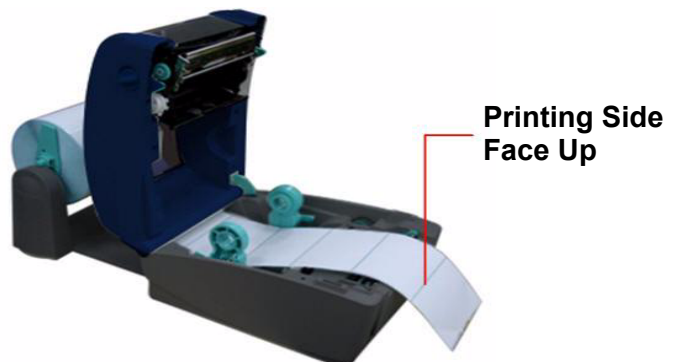
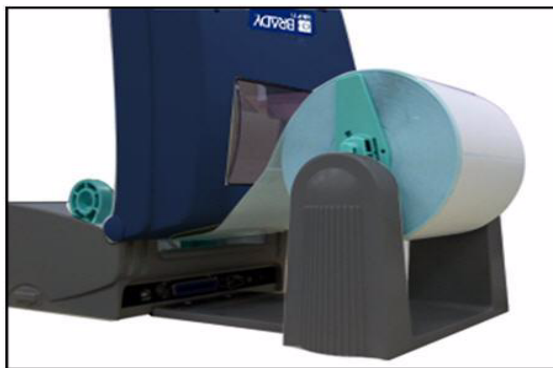

6. Move the media guides to fit the label width by turning the guide adjuster knob.
7. Disengage the top cover support and close the top cover gently.



8. Use the **Diagnostic Tool** to set the media sensor type and calibrate the selected sensor (see the diagnostic utility quick start guide for more information):
  - a. Start **Diagnostic tool**.
  - b. Select **Printer Configuration** tab.
  - c. Click **Calibrate Sensor** button.

## Diagnostic Tool

The Diagnostic Utility is a toolbox that lets users explore the printer's settings and status; change printer settings; download graphics, fonts, and firmware; create printer bitmap fonts; and to send additional commands to the printer. Using this convenient tool, you can explore the printer status and settings and troubleshoot the printer.

**Note:** This utility works with printer firmware V6.00 and later versions.

### Start the Diagnostic Tool

1. To start the software, double click the **Diagnostic** tool icon  `DiagTool.exe`.

**Note:** The diagnostic tool is located at **D:\DiagTool**.

2. There are four features (**Printer Configuration**, **File Manager**, **Bitmap Font Manager**, **Command Tool**) included in the *Diagnostic* utility.

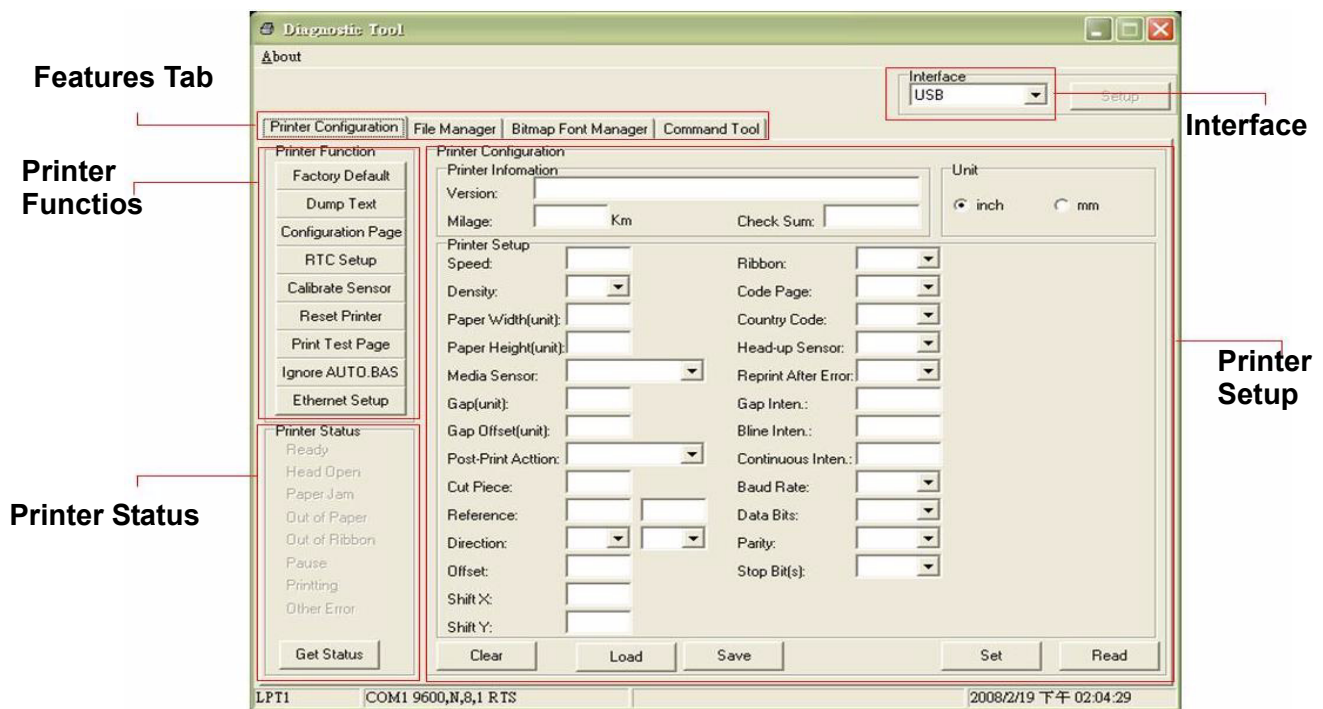

### **Printer Function (Calibrate Sensor, Ethernet Setup, RTC Setup...)**

1. Select the PC interface connected to the bar code printer.
2. Click **Function** to set.
3. The detail functions in the *Printer Function Group* are listed in the table.

	<b>Function</b>	<b>Description</b>
Printer Function	Factory Default	Initialize the printer and restore the settings to factory default.
Factory Default	Dump Text	Activate the printer dump mode.
Dump Text	Configuration Page	Print printer configuration.
Configuration Page	RTC Setup	Synchronize printer Real Time Clock with PC.
RTC Setup	Calibrate Sensor	Calibrate the sensor specified in the Printer Setup group media sensor field.
Calibrate Sensor	Reset Printer	Reboot the printer.
Reset Printer	Print Test Page	Print a test page.
Print Test Page	Ignore AUTO.BAS	Ignore the downloaded AUTO.BAS program.
Ignore AUTO.BAS	Ethernet Setup	Setup the IP address, subnet mask, gateway for the on board Ethernet.
Ethernet Setup		

---

**Note:** For more information about Diagnostic Tool, refer to the diagnostic utility quick start guide in the CD disk \ Utilities directory.

---

# Install SD Memory Card

1. Open the SD memory card cover.



2. Insert the SD card until it is fully seated.



3. Close the memory card cover.



<b>* Recommended SD Card Specifications</b>	
SD V 1.0, V 1.1	SD V 2.0 (SDHC)
✓ 128 MB ✓ 256 MB ✓ 512 MB ✓ 1 GB	✓ 4 GB class 6
- Supported DOS FAT file system. - Folders stored on the SD card should be in the 8.3 filename format. - Approved SD card manufacturer: SanDisk, Transcend.	

This printer has one button and one three-color LED indicator. By the button when the LED indicates a different color, the printer can be set to feed labels, pause the printing job, select and calibrate the media sensor, print a printer self-test report, reset the printer to defaults (initialization). See the following button operation descriptions for functions.

## LED Indicator

LED Color	Description
Green/ Solid	Illuminates when power is on and the device is ready to use.
Green/ Flash	Illuminates when the system is downloading data from PC to memory or the printer is paused.
Amber	Illuminates when the system is clearing data from printer.
Red / Solid	Illuminates when the printer head is open, or a cutter error.
Red / Flash	Illuminates when there is a printing error, such as head open, paper empty, paper jam, ribbon empty, or memory error etc.

## Regular Button Function

1. **Feed labels:**

When the printer is ready, press the button to feed one label to the beginning of the next label.

2. **Pause the printing job:**

When the printer is printing, press the button to pause a print job. When the printer is paused the LED will blink green. Press the button again to continue the printing job.

## Power on Utilities

There are six power-on utilities to set up and test printer hardware. These utilities are activated by pressing **FEED**, then turning on the printer power simultaneously and releasing the button at a different LED color.

**Follow these steps for various power-on utilities:**

1. Turn off the power switch.
2. Hold the **Feed** button down, then turn the power switch **ON**.
3. Release the button when LED indicates a color for a different function.

Power on Utilities	LED color changes as follows:						
LED Color	Amber	Red (5 blinks)	Amber (5 blinks)	Green (5 blinks)	Green/Amber (5 blinks)	Red/Amber (5 blinks)	Solid green
<b>Functions</b>							
1. Ribbon Sensor Calibration and Gap / black mark sensor calibration		Release					
2. Gap / black mark sensor calibration, Self-test and enter dump mode			Release				
3. Printer initialization				Release			
4. Set black mark sensor as media sensor and calibrate the black mark sensor					Release		
5. Set gap sensor as media sensor and calibrate the gap sensor						Release	
6. Skip AUTO.BAS							Release

### **Ribbon and Gap/Black Mark Sensor Calibration**

Calibrate gap/black mark sensor sensitivity at the following conditions:

- New printer
- Change label stock
- Printer initialization

**Follow these steps to calibrate the ribbon and gap/black mark sensor:**

1. Turn off the power switch.
2. Hold the **Feed** button down, then turn the power switch **ON**.
3. Release the button when LED turns **red** and blinks. (Any time during the 5 blinks).
  - The ribbon sensor and gap/black mark sensor sensitivity will be calibrated.
  - The LED color will change in the following order:
    - **Amber** → **Red** (5 blinks) → **Amber** (5 blinks) → **Green** (5 blinks) → **Green/Amber** (5 blinks) → **Red/Amber** (5 blinks) → **Solid Green**

---

**Note:** Select gap or black mark sensor by sending GAP or BLINE command to the printer before calibrating the sensor.

---



## Gap/Black Mark Calibration, Self-test and Dump Mode

While calibrating the gap/black mark sensor, the printer will measure the label length, print the internal configuration (self-test) on a label and then enter the dump mode. Calibrating the gap or black mark sensor depends on the sensor setting in the last print job.

### To calibrate the sensor:

1. Turn off the power switch.
2. Hold the **Feed** button down, then turn the power switch **ON**.
3. Release the button when LED turns **amber** and blinks (any time during the 5 blinks).

The LED color will change in the following sequence:

- **Amber** → **Red** (5 blinks) → **Amber** (5 blinks) → **Green** (5 blinks) → **Green/Amber** (5 blinks) → **Red/Amber** (5 blinks) → **Solid Green**
4. The printer calibrates the sensor, measures the label length and prints internal settings then enters the dump mode.

---

**Note:** Select gap or black mark sensor by sending GAP or BLINE command to the printer before calibrating the sensor.

---

### Self-Test

The printer will print the printer configuration after a gap/black mark sensor calibration. The self-test printout can be used to check if there is any dot damage on the heater element, printer configurations and available memory space.

```
PRINTER INFO.
[REDACTED]
BBP-11-24 Version: 6.58 EZ
MILAGE(m): 50
CHECKSUM: 05C90947 TCF
SERIAL PORT: 9600,N,8,1
CODE PAGE: 850
COUNTRY CODE: 001
SPEED: 2 INCH
DENSITY: 10.0
SIZE: 1.50 , 6.50
GAP: 0.13 , 0.00
TRANSPARENCE: 11
MAC ADDRESS: 00-1B-82-FF-01-97
DHCP ENABLED: YES
IP ADDRESS: 0.0.0.0
SUBNET MASK: 0.0.0.0
DEFAULT GATEWAY: 0.0.0.0
*****
FILE LIST:
DRAM FILE:          0 FILE(S)
FLASH FILE:         0 FILE(S)
PHYSICAL DRAM:      8192 KBYTES
AVAILABLE DRAM:     256 KBYTES FREE
PHYSICAL FLASH:     2048 KBYTES
AVAILABLE FLASH:    1088 KBYTES FREE
END OF FILE LIST
*****
NOW IN DUMP MODE
```

Print Head Test Pattern

Printer Model Name & ManBoard Firmware Version

Printed Mileage

Main Board Firmae Checksum

Serial Port Setting

Code Page

Country Cd

Print Speed

Print Darkns

Label Size (wit, height)

Gap Size (vertical gap, ofst)

Sensor Sensitivity

File Management Information



## Dump Mode

The printer enters dump mode after printing the printer configuration. In the dump mode, all characters are printed in 2 columns as shown. The ASCII characters are received from your system and right side data shows the corresponding hexadecimal value of the characters. It allows users or engineers to verify and debug the program.

```
ASCII Data → | SPEED 2.0 53 50 45 45 44 20 32 2E 30 0D |
               | DENSITY 8 0A 44 45 4E 53 49 54 59 20 38 |
               | SET PEEL 0D 0A 53 45 54 20 50 45 45 4C |
               | OFF DIRE 2D 4F 46 46 0D 0A 44 49 52 45 |
               | CTION 0 0 43 54 49 4F 4E 20 30 0D 0A 47 |
               | AP 3.00 mm 41 50 20 33 2E 30 30 20 6D 6D |
               | .0.00 mm 2C 30 2E 30 30 20 6D 6D 0D 0A |
               | REFERENCE 52 45 46 46 52 45 4E 43 45 20 |
               | 0.0 SET C 30 2C 30 0D 0A 53 45 54 20 43 |
               | CUTTER OFF 55 54 54 45 52 20 4F 46 46 09 |
               | SIZE 100. 0A 53 49 5A 45 20 31 30 30 2E |
               | 02 mm, 65.0 39 32 20 6D 6D 2C 36 35 2E 30 |
               | 4 mm CLS 34 29 6D 6D 0D 0A 43 4C 53 0D |
               | BARCODE 1 0A 42 41 52 43 4F 44 45 20 31 |
               | 44,149,"39 34 34 2C 31 34 39 2C 22 33 39 |
               | ".120,1.0. 22 2C 31 32 30 2C 31 2C 30 2C |
               | 2.6,"57114 32 2C 36 2C 22 35 37 31 31 34 |
               | 3BT+ PRIN 33 38 54 22 0D 0A 50 52 49 4E |
               | T 1,1 SPE 54 20 31 2C 31 0D 0A 53 50 45 |
               | ED 2.0 DE 45 44 20 32 2E 30 0D 0A 44 45 |
               | NSITY 8 5 4E 53 49 54 59 20 38 0D 0A 53 |
               |
               | ET PEEL OF 45 54 20 50 45 45 4C 20 4F 46 |
               | F DIRECTI 46 0D 0A 44 49 52 45 43 54 49 |
               | ON 0 GAP 4F 4E 20 30 0D 0A 47 41 50 20 |
               | 3.00 mm,0. 33 2E 30 30 20 6D 6D 2C 30 2E |
               | 00 mm REF 30 30 20 6D 6D 0D 0A 52 45 46 |
               | ERENCE 0.0 45 52 45 4E 43 45 20 30 2C 30 |
               | SET CUTT 0D 0A 53 45 54 20 43 55 54 54 |
               | ER OFF S1 45 52 20 4F 46 46 0D 0A 53 49 |
               | ZE 100.02 5A 45 20 31 30 30 2E 30 32 20 |
               | mm, 65.04 m 6D 6D 2C 36 35 2E 30 34 20 6D |
               | m CLS BA 6D 0D 0A 43 4C 53 0D 0A 42 41 |
               | RCODE 144. 52 43 4F 44 45 20 31 34 34 2C |
               | 149,"39",1 31 34 39 2C 22 33 39 22 2C 31 |
               | 20,1.0,2.0 32 30 2C 31 2C 30 2C 32 2C 30 |
               | ."571143BT 2C 22 35 37 31 31 34 33 38 54 |
               | . PRINT 1 22 0D 0A 50 52 49 4E 54 20 31 |
               | ,1 2C 31 0D 0A |
```

Hex decimal data related to left column of ASCII data

- 
- Notes:**
- 1. Dump mode requires 4" wide paper width.
  - 2. Turn off / on the power to resume printer for normal printing.
  - 3. Press FEED button to go back to the previous menu.
- 

## Printer Initialization

Printer initialization is used to clear DRAM and restore printer settings to defaults. The only exception is ribbon sensitivity, which will not be restored to default.

### To activate Printer initialization:

1. Turn off the power switch.
2. Hold the **Feed** button down, then turn the power switch **ON**.
3. Release the button when the LED turns **green** after 5 amber blinks. (Any time during the 5 blinks).

The LED color changes as follows:

- **Amber** → **Red** (5 blinks) → **Amber** (5 blinks) → **Green** (5 blinks) → **Green/Amber** (5 blinks) → **Red/Amber** (5 blinks) → **Solid Green**

After initialization, printer configuration will be restored to defaults as shown in the table.

Parameter	Default setting
Speed	127 mm/sec (5 ips) (203DPI) 76 mm/sec (3 ips) (300DPI)
Density	8
Label Width	4" (101.5 mm)
Label Height	4" (101.5 mm)
Sensor Type	Gap sensor
Gap Setting	0.12" (3.0 mm)
Print Direction	0
Reference Point	0,0 (upper left corner)
Offset	0
Tear Mode	On
Peel off Mode	Off
Cutter Mode	Off
Serial Port Settings	9600 bps, none parity, 8 data bits, 1 stop bit
Code Page	850
Country Code	001
Clear Flash Memory	No
IP Address	DHCP

### ***Set Black Mark Sensor as Media Sensor and Calibrate the Black Mark Sensor***

#### ***To set Black Mark Sensor:***

1. Turn off the power switch.
2. Hold the **Feed** button down, then turn the power switch **ON**.
3. Release the ONbutton when LED turns **green/amber** after 5 green blinks. (Any green/amber will do during the 5 blinks).

The LED color changes as follows:

- **Amber** → **Red** (5 blinks) → **Amber** (5 blinks) → **Green** (5 blinks) → **Green/Amber** (5 blinks) → **Red/Amber** (5 blinks) → **Solid Green**

### ***Set Gap Sensor as Media Sensor and Calibrate the Gap Sensor***

#### ***To set Gap Sensor:***

1. Turn off the power switch.
2. Hold the **Feed** button down, then turn the power switch **ON**.
3. Release the button when LED turns **red/amber** after 5 green/amber blinks (any time during the 5 blinks).

The LED color changes as follows:

- **Amber** → **Red** (5 blinks) → **Amber** (5 blinks) → **Green** (5 blinks) → **Green/Amber** (5 blinks) → **Red/Amber** (5 blinks) → **Solid Green**

## ***Skip AUTO.BAS***

TSPL2 programming language lets users download an auto execution file to flash memory. The printer will run the AUTO.BAS program immediately when printer power is turned on. The AUTO.BAS program can be interrupted without using the power-on utility to run the program.

### ***To skip an AUTO.BAS program:***

1. Turn off printer power.
2. Press the FEED button and then turn on power.
3. Release the FEED button when LED turns **solid green**.

The LED color changes as follows:

- **Amber → Red (5 blinks) → Amber (5 blinks) → Green (5 blinks) → Green/Amber (5 blinks) → Red/Amber (5 blinks) → Solid Green**
4. Printer will be interrupted to run the AUTO.BAS program.

The following guide lists the most common problems that may be encountered when operating this bar code printer. If the printer still does not function after all suggested solutions have been tried, please contact the Customer Service Department of your purchased reseller or distributor for assistance.

## LED Status

This section provides solutions to common problems indicated by the LED status that you may encounter when operating the printer.

LED Status / Color	Printer Status	Possible Cause	Recovery Procedure
OFF	No response	No power	<ul style="list-style-type: none"> <li>• Turn on the power switch.</li> <li>• Check if the green LED is lit on power supply. If it is not lit, the power supply is broken.</li> <li>• Check if both the power connections from the power cord to the power supply and from the power supply to the printer power jack are connected securely.</li> </ul>
Solid Green	ON	The printer is ready to use	<ul style="list-style-type: none"> <li>• No action necessary.</li> </ul>
Green with blinking	Pause	The printer is paused	<ul style="list-style-type: none"> <li>• Press the FEED button to resume printing.</li> </ul>
Red with blinking	Error	<p>The Out of Label or Ribbon.</p> <p>Printer setting is not correct</p>	<ol style="list-style-type: none"> <li>1. Out of label or ribbon: <ul style="list-style-type: none"> <li>• Load a label roll following media loading instructions, then press FEED to resume printing.</li> <li>• Load a label roll following ribbon loading instructions, then press FEED to resume printing.</li> </ul> </li> <li>2. Printer setting is not correct: <ul style="list-style-type: none"> <li>• Initialize the printer by following the instructions in “Power on Utility” or “Diagnostic Tool.”</li> </ul> </li> </ol>

**Note:** Printer status can be viewed in the Diagnostic Tool. For more information about the Diagnostic Tool, see the instructions in the software CD disc located at **D:\DiagTool**.

## Print Quality

Problem	Possible Cause	Recovery Procedure
<b>Not Printing</b>	Check if interface cable is properly connected to the interface connector.	Re-connect cable to interface.
	The serial port cable pin configuration is not a pin-to-pin connection.	Replace the cable with pin to pin connection.
	The serial port setting is not consistent between host and printer.	Reset the serial port setting.
	The port specified in the Windows driver is not correct.	Select the correct printer port in the driver.
	The Ethernet IP, subnet mask, gateway is not configured properly.	Configure the IP, subnet mask and gateway.
<b>No print on the label</b>	Label or ribbon loaded not correctly.	Follow the instructions in loading the media or loading the ribbon.
	Out of Ribbon.	Load new ribbon.
<b>Continuous feeding labels</b>	The printer setting may be wrong.	Perform the initialization and gap/black mark calibration.
<b>Paper Jam</b>	Gap/black mark sensor sensitivity is not set properly (sensor sensitivity is not enough).	Calibrate the gap/black mark sensor.
	Label size is not set properly.	Set label size exactly as installed paper in the labeling software or program.
	Labels are stuck inside the printer mechanism near the sensor area.	Remove the stuck label.
<b>Poor Print Quality</b>	Top cover is not closed properly.	Close the top cover completely and make sure the right- and left-side levers are latched properly.
	Supply is loaded incorrectly.	Reload the supply.
	Ribbon and media are incompatible.	Change the ribbon or label combination.
	Dust and/or adhesives are accumulated on the print head.	Check if dust or adhesives are accumulated on the print head. Clean the print head.
	Print density is not set properly.	Adjust the print density and print speed.
	Print head test pattern is incorrect.	Head element may be damaged. Run printer self-test and check the print head test pattern to see if there are missing dots in the pattern.

# Maintenance

This session presents the cleaning tools and methods to maintain your printer.

1. Use one of following materials to clean the printer:

- Cotton swab (Head cleaner pen)
- Lint-free cloth
- Vacuum / Blower brush
- 100% ethanol

2. Clean the printer using the following process:

Printer Part	Method	Interval
<b>Print Head</b>	1. Turn off the printer before cleaning the print head. 2. Allow the print head to cool for a minimum of one minute. 3. Use a cotton swab and 100% acetone to clean the print head surface.	Clean the print head when changing a new label roll.
	<p>The diagram illustrates the cleaning process for the print head. It shows a hand holding a 'Head Cleaner Pen' and applying it to the 'Print Head' surface. A callout box provides a detailed view of the 'Print Head' and its 'Element'.</p>	
<b>Platen Roller</b>	1. Turn the power off. 2. Rotate the platen roller and wipe it thoroughly with 100% ethanol or acetone and a cotton swab, or lint-free cloth.	Clean the platen roller when changing a new label roll
<b>Sensor</b>	Compressed air or vacuum	Monthly
<b>Exterior</b>	Wipe it with water-dampened cloth	As needed
<b>Interior</b>	Brush or vacuum	As needed

- 
- Notes:**
- Do not touch the printer head. If you touch it, use ethanol to clean it.
  - Use 100% Acetone or Ethenol. DO NOT use medical alcohol, which may damage the printer head.
  - **To maintain printer performance and extend printer life, clean the print head and supply sensors whenever you change a new ribbon.**
  - Continuous printing will cause the printer motor to overheat. Printer will stop printing automatically about every 10~15 minutes until motor is cooled down. Data transfered to printer buffer will be lost if power to the printer is turned off when the printer pauses.
-







Copyright 2009 Brady Worldwide, Inc.

All Rights Reserved  
BRADY WORLDWIDE, INC.  
6835 Winnetka Circle, Brooklyn Park, MN 55428